

Werk

Jahr: 1985

Kollektion: fid.geo

Signatur: 8 Z NAT 2148:57

Digitalisiert: Niedersächsische Staats- und Universitätsbibliothek Göttingen

Werk Id: PPN1015067948_0057

PURL: http://resolver.sub.uni-goettingen.de/purl?PPN1015067948_0057

LOG Id: LOG_0014

LOG Titel: The formulae for the calculation of the Fresnel zones or volumes

LOG Typ: article

Übergeordnetes Werk

Werk Id: PPN1015067948

PURL: <http://resolver.sub.uni-goettingen.de/purl?PPN1015067948>

OPAC: <http://opac.sub.uni-goettingen.de/DB=1/PPN?PPN=1015067948>

Terms and Conditions

The Goettingen State and University Library provides access to digitized documents strictly for noncommercial educational, research and private purposes and makes no warranty with regard to their use for other purposes. Some of our collections are protected by copyright. Publication and/or broadcast in any form (including electronic) requires prior written permission from the Goettingen State- and University Library.

Each copy of any part of this document must contain these Terms and Conditions. With the usage of the library's online system to access or download a digitized document you accept the Terms and Conditions.

Reproductions of material on the web site may not be made for or donated to other repositories, nor may be further reproduced without written permission from the Goettingen State- and University Library.

For reproduction requests and permissions, please contact us. If citing materials, please give proper attribution of the source.

Contact

Niedersächsische Staats- und Universitätsbibliothek Göttingen
Georg-August-Universität Göttingen
Platz der Göttinger Sieben 1
37073 Göttingen
Germany
Email: gdz@sub.uni-goettingen.de

The formulae for the calculation of the Fresnel zones or volumes

B. Gelchinsky

Department of Geophysics and Planetary Sciences, Tel-Aviv University, Ramat-Aviv, Tel Aviv 69978, Israel

Abstract. The symmetrized invariant formulae for the calculation of Fresnel zones or volumes are derived. It is assumed that an inhomogeneous medium with curvilinear interfaces is located between the source and/or the receiver and along the central ray within the Fresnel zone or volume. In the vicinity of the zone centre, the medium is considered locally homogeneous.

The formula for the leading term of the field of a wave scattered by a bent body immersed in the above-mentioned medium is obtained by the Kirchhoff approximation. With the help of this formula and the expressions for the Fresnel radii for a particular case, the formulae for the Fresnel zones in the general case considered are obtained on the basis of the reciprocity relation. The formulae for the Fresnel zones are used to obtain the expressions for the Fresnel volumes.

The physical consequences of the derived formulae with respect to the validity of the ray formulae and the resolution of seismic methods etc. are discussed.

Key words: Area essential for reflection (propagation) – Symmetrized invariant formulae – Validity conditions – Resolution.

Introduction

The Fresnel diffraction theory has occupied a central position in optics and in the theory of wave propagation in general since 1818, when a well-known Fresnel memoir appeared. In 1882, Kirchhoff gave the Fresnel diffraction theory a rigorous mathematical foundation; since that time the explanation of diffraction and wave propagation has been based essentially on the Fresnel-Kirchhoff theory. The concept of Fresnel zones plays an important role in this theory and is continually being developed and generalized.

This problem has been examined in many books and articles and it is impossible to review them all here. We shall mention only the works of Al'pert et al. (1953), Bertoni et al. (1971) and Kravtsov and Orlov (1980) in which special attention is paid to the consideration of regions essential to the formation of fields of reflected and transmitted waves¹. This problem was

investigated in depth in the book by Kravtsov and Orlov (1980). The following points connected with the Fresnel volume are considered on a heuristic basis: an area of ray localization, a finite thickness of physical ray, an area of applicability and resolution of the ray method.

In the seismic literature, a certain amount of attention is paid to the question of computation of the Fresnel zones and their connection with the resolution of the seismic method (see, for example, Hagedoorn, 1959; Hilterman, 1970; Sheriff, 1980; Sheriff and Geldart, 1982; Kleyn, 1983). However, only the simplest cases are considered while, in practice media of a rather complicated structure are generally encountered. However, as far as we know, the formulae for computation of the Fresnel zones and volumes for the case of a sufficiently complicated structure have not been given, although many formulae for the Fresnel zones for various particular cases are presented in the literature (Tatarsky, 1967; Flatte, 1979; Kravtsov and Orlov, 1980).

The aim of the present paper is to derive symmetrized invariant formulae for the computation of Fresnel zones and volumes for media of complex structure². In this paper it is assumed that an inhomogeneous medium with curvilinear interfaces is located between the sources and/or the receiver and the centre of the zone or volume. There is one restriction: in the vicinity of the zone (or volume) centre the medium is considered locally homogeneous.

In order to show how the notion of the Fresnel zones appears in the Fresnel-Kirchhoff theory, we first consider the problem of the scattering of a wave on a body of arbitrary shape. This consideration is also the basis for determining the Fresnel volume. Since the techniques of evaluation of integrals obtained in the Fresnel-Kirchhoff theory are well known (Keller, 1957; Bleistein and Handelsman, 1975; Born and Wolf, 1980; Felsen and Marcuvitz, 1973), the computational scheme with some improvements concerning the smooth continuation of a surface beyond the body contour (Gelchinsky, 1982a) is presented in a very brief form.

In conclusion, some physical consequences of the

¹ Let us note, by the way, that there is no conventional terminology for an area essential for wave propagation. Bertoni et al. (1971) call it the 3-D Fresnel zone and Kravtsov and Orlov (1980), the Fresnel volume. We use the terminology of the latter

² A formula has an invariant form if the quantities included in it do not depend on the choice of the coordinate system. We say that a formula is written in a symmetrized form if the reciprocity principle follows *explicitly* from the written form

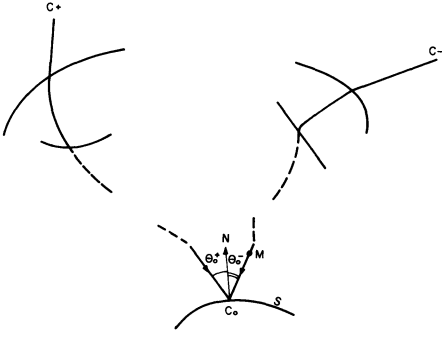

Fig. 1. Ray path for considered model (a 2-D ray scheme is shown for simplicity). C^+ is the point of emission; C^- is the point of observation; S is the scattering surface; θ_0^+ and θ_0^- are angles of incidence in positive and negative directions; C_0 is the specular point

derived formulae are discussed. We try to present this discussion so that readers unfamiliar with the derivation of the formulae obtained can, at least, understand their consequences.

Derivation of a formula for the field of a scattered wave in the Kirchhoff approximation

Let a time harmonic wave with frequency ω fall on the surface S of a body and let the time dependence $\exp(-i\omega t)$ be ignored. The field of the scattered wave $U(M)$ at the point M can be determined by the Green formula (often known as the Kirchhoff formula in the case of a scalar wave equation):

$$U(M) = \iint \left\{ U(C) \frac{\partial G(M, C)}{\partial N} - G(M, C) \frac{\partial U(C)}{\partial N} \right\} dS(C), \quad (1)$$

where $G(M, C)$ is the Green function with the source at point M and the receiver at point C on S , and $\partial/\partial N$ denotes differentiation with respect to the normal \mathbf{N} to the surface S .

Since the shape of the contour limiting the surface S , and also the type of the point source, does not influence the parameters of the Fresnel zone or volume, we limit ourselves to the consideration of scattering of a wave excited by a point source in the form of the δ -function, at a general curvilinear surface having the form of a bent rectangle.

In the following, we will use the reciprocity relation, changing the source and the receiver at the fixed points C^+ and C^- . In this way the wave motion in the positive direction (the path $C^+ \dots C_0 \dots C^-$) as well as in the negative one (the path $C^- \dots C_0 \dots C^+$) will be considered (Fig. 1). When the wave scattering in the positive (negative) direction is treated, the field of the incident wave will be denoted as $U_0(C^+, C)$ or $U_0^+(C)$ [$U_0(C^-, C)$ or $U_0^-(C)$], where the point C is located on the surface S . Under the given conditions, the Green function $G(C^{(v)}, C)$ [$v = +$ or $-$] and the incident field $U_0^{(v)}(C)$ are equal. The leading part of these fields can be written in the form:

$$U_0^{(v)}(C_0) = U_0(C^{(v)}, C) = G(C^{(v)}, C) = I_0^{(v)}(C) \exp\{i\omega\tau_0^{(v)}(C)\}, \quad (v = + \text{ or } -), \quad (2)$$

where $I_0^{(v)}(C)$ is the amplitude and $\tau_0^{(v)}(C)$ is the time of propagation (eiconal) of the incident wave from the source at the point $C^{(v)}$ to the point C .

It is assumed that the front ($\tau^{(v)} = \text{constant}$) of the wave moving in the v -th direction is of arbitrary shape. This means that an inhomogeneous medium with curved interfaces could exist between the source (or the receiver) at the point $C^{(v)}$ and the point of observation, C . In the vicinity of the point C on the scattering surface S , the medium is considered to be homogeneous.

It is known (Alekseev and Gelchinsky, 1959; Červený and Ravindra, 1971) that, in the Kirchhoff approximation, the amplitude of the scattered wave on the surface S at the point C is determined by the relation:

$$I^{(v)}(C) = \begin{cases} K(\theta_0, \omega) I_0^{(v)}(C) & \text{in the lit area} \\ 0 & \text{in the shadow} \end{cases} \quad (3)$$

where $K(\theta_0, \omega)$ is the coefficient of reflection (transmission) depending on the angle of incidence θ_0 and the frequency ω . The leading part of the scattered field $U(M)$ at the point M in the vicinity of the surface S may be represented by the formula:

$$U^{(v)}(M) = I^{(v)}(C) \left\{ \frac{d\Sigma(M)}{d\Sigma(C)} \right\}^{\frac{1}{2}} \exp\left\{i\omega \left[\tau^{(v)}(C) + \frac{\Delta l}{v} \right]\right\}, \quad (4)$$

where $\Delta l = CM$ is the ray path between the point C and the nearby point M , v is the propagation velocity of the scattered wave and $\left\{ \frac{d\Sigma(M)}{d\Sigma(C)} \right\}^{\frac{1}{2}}$ is the geometrical spreading function of the scattered wave.

If we now consider the scattering of a wave moving in the positive direction³ and substitute the expressions of the field $U(C^+, C)$ and the Green function $G(C^-, C)$ and of its derivatives according to formulae (2)–(4) in Eq. (1), we obtain the following integral:

$$U(C^+, C^-) = \iint_S F(C) \exp\{i\omega\tau(C)\} dS, \quad (5)$$

where

$$F(C) = \frac{-i\omega}{4} I_0^{(+)}(C) I_0^{(-)}(C) K\{\theta^-(C)\}, \quad (6)$$

$$\tau(C) = \tau(C^+, C, C^-) = \tau_0^{(+)}(C_0) + \tau_0^{(-)}(C_0). \quad (7)$$

Since the function $F(C)$ can usually be considered to be a slowly varying function⁴, the approximate value of the integral (5) can be obtained by the well-known method of stationary phase (MSP) (Keller, 1957; Felsen and Marcuvitz, 1973; Bleistein and Handelsman, 1975). The results of computations can be presented in the form (Gelchinsky, 1982a):

$$U(C^+, C^-) = U_{\text{ray}}(C^+, C^-) W(C^+, C^-), \quad (8)$$

³ If a wave moves in the positive direction, the source is at the point C^+ and the point of observation coincides with the receiver C^- .

⁴ We shall later recall some of the physical conditions under which the function F can be considered as a slowly varying one.

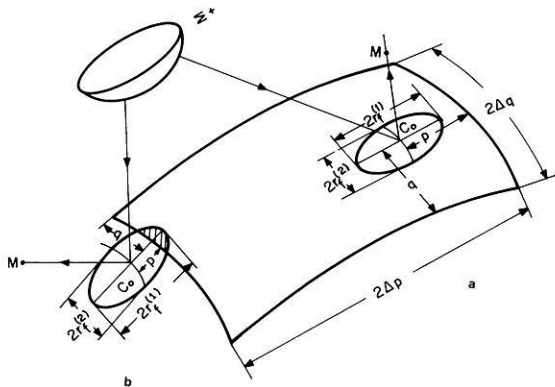

Fig. 2 a and b. The Fresnel zone on the curved rectangle, S : **a** Real point of reflection (*lit area*). **b** Fictitious point of reflection (*shadow part of half-shadow area*). $r_f^{(1)}$ and $r_f^{(2)}$ are half-axes (radii) of the curved Fresnel zone; p and q are distances from C_0 to the nearest edge of the rectangle; $2\Delta p$ and $2\Delta q$ are the length and width of the rectangle, respectively; Σ^+ is the front of the wave incident in the positive direction

where U_{ray} is equal to the leading part of the reflected wavefield calculated according to the formulae of the ray method (Alekseev and Gelchinsky, 1959; Červený and Ravindra, 1971) as if the surface S were unbounded.

W is the so-called weakening function which takes account of the influence of the restricted size of the surface S on the scattered field. When S is a bent rectangle, the function W can be presented in the form of the product of two Fresnel integrals (Gelchinsky, 1982a):

$$W = \left\{ (2i)^{\frac{1}{2}} \int_{\xi_1}^{\xi_2} \exp(i\pi X^2/2) dX \right\} \cdot \left\{ (2i)^{\frac{1}{2}} \int_{\eta_1}^{\eta_2} \exp(i\pi X^2/2) dX \right\}, \quad (9)$$

where:

$$\xi_1 = \frac{2^{\frac{1}{2}} p}{r_f^{(1)}}, \quad \xi_2 = \frac{2^{\frac{1}{2}} (2\Delta p - p)}{r_f^{(1)}},$$

$$\eta_1 = \frac{2^{\frac{1}{2}} q}{r_f^{(2)}}, \quad \eta_2 = \frac{2^{\frac{1}{2}} (2\Delta q - q)}{r_f^{(2)}}. \quad (10)$$

The arguments, (10), of each of the integrals (9) are dimensionless ratios of certain distances, $p(q)$ and $2\Delta p - p$ ($2\Delta q - q$), and of a certain characteristic size, $r_f^{(1)}$ ($r_f^{(2)}$). The geometrical sense of these quantities is explained in Fig. 2. The quantity $p(q)$ is the distance from the specular point C_0 , computed by the laws of geometrical optics when the positions of the points C^+ and C^- are fixed, to the closest edge of the rectangle. This distance is measured along the surface S parallel to the corresponding side of this rectangle; $2\Delta p - p$ ($2\Delta q - q$) is the distance to the opposite side of the rectangle.

The quantities $r_f^{(1)}$ and $r_f^{(2)}$ are the radii (half-axes) of the Fresnel zones on the surface S with the centre at the specular point C_0 (Fig. 2). The position of C_0

(when the points C^+ and C^- are fixed) is determined by the condition of stationary phase (Snell's law):

$$\frac{\partial \tau}{\partial \xi_1} = \frac{\partial \tau}{\partial \xi_2} = 0 \quad \text{at the point } C_0, \quad (11)$$

where ξ_1 and ξ_2 are curvilinear coordinates on the surface S .

In Fig. 2 two cases are shown: the first when the point C_0 is located in the lit area and the second when it is in the so-called half-shadow, where the point C_0 is located not far from the edge of S at a distance smaller than the respective Fresnel radius. In particular, the point C_0 can be located beyond the body's contour on the so-called smooth continuation of the surface S (a detailed description is given in Gelchinsky, 1982a). This is a fictitious specular point.

The quantity $p_f^{(i)}$ ($i=1, 2$) is determined by the expression:

$$\frac{1}{r_f^{(i)}} = \left\{ \frac{|\alpha + \beta - (-1)^i [(\alpha - \beta)^2 + \gamma^2]^{\frac{1}{2}}|}{2} \right\}^{\frac{1}{2}}, \quad (12)$$

where α , β and γ are second derivatives of eiconal τ

$$a = \frac{\omega}{\pi} \frac{\partial^2 \tau}{\partial \xi_1^2}, \quad \beta = \frac{\omega}{\pi} \frac{\partial^2 \tau}{\partial \xi_2^2},$$

$$\gamma = \frac{2\omega}{\pi} \frac{\partial^2 \tau}{\partial \xi_1 \partial \xi_2} \quad \text{at point } C_0 \quad (13)$$

in an orthogonal curvilinear coordinate system where $\xi_1 = \xi_{\parallel}$ and $\xi_2 = \xi_{\perp}$, when the origin is located at the specular point, the tangent to the line ξ_{\parallel} at the point C_0 is in the plane of incidence E_{\parallel} , and the tangent to the line ξ_{\perp} is perpendicular to E_{\parallel} .

It is easy to show for a fixed ray $C^+ \dots C_0 \dots C^-$ using the expression:

$$\tau(C) = \tau(C_0) + \frac{\pi\alpha}{2\omega} \xi_{\parallel}^2 + \frac{\eta\beta}{2\omega} \xi_{\perp}^2 + \frac{\pi\gamma}{\omega} \xi_{\parallel} \xi_{\perp}$$

$$= \tau(C_0) + \frac{\pi}{\omega} \left\{ \frac{p^2}{(r_f^{(1)})^2} + \frac{q^2}{(r_f^{(2)})^2} \right\} \quad (14)$$

that the closed line, the coordinates of which, p^* and q^* , satisfy the expression

$$\tau(C) - \tau(C_0) \equiv \frac{\pi}{\omega} \left[\frac{p_*^2}{(r_f^{(1)})^2} + \frac{q_*^2}{(r_f^{(2)})^2} \right] = \frac{T}{2} \quad (15)$$

where T is the period of wave, determines the boundary of the first Fresnel zone on the surface S . It is easy to see from Eq. (14) that the axes of the Fresnel zone coincide with the axes of the orthogonal curvilinear coordinate system p, q . The angle between the tangents to the lines ξ_{\parallel} and p is determined by the relation:

$$\cos \delta = \left[\frac{1}{2} \left(1 + \frac{\alpha - \beta}{[(\beta - \alpha)^2 + \gamma^2]^{\frac{1}{2}}} \right) \right]^{\frac{1}{2}}. \quad (16)$$

In some cases, it is convenient to introduce the so-called image plane Q , tangent to surface S at the reflection point C_0 (Fig. 3). On this plane the coordinate system x, y is considered where the coordinate line x

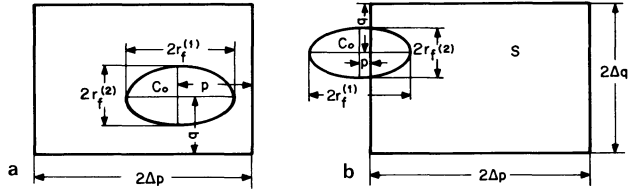

Fig. 3a and b. Images of the curved rectangle S and of the Fresnel zone in the image plane Q : **a** Real point of reflection (*lit area*). **b** Fictitious point (*shadowed area*)

(or y) is tangent to the line p (or q) at the point C_0 . On the plane Q the Fresnel zone is an ellipse with centre at the specular point C_0 and the surface S is imaged into a planar rectangle with sides $2\Delta p$ and $2\Delta q$ (see Gelchinsky, 1982a).

The formulae (12) for the Fresnel radii are not convenient for qualitative physical considerations as well as for computations since they include second derivatives, Eq. (13), of the eiconal $\tau(C)$ (in Eq. (7)) which are rather difficult to compute numerically in the case of complex media.

Derivation of invariant symmetrized formulae for second derivatives of the eiconal

In order to obtain the invariant formulae for second derivatives of the time of wave propagation, one can use the various methods developed for derivations of the formulae for the geometrical spreading function or for the curvature of the wavefront (see, for example, Gelchinsky, 1961, 1982; Deschamps, 1972; Hubral, 1980; Hubral and Krey, 1980). However, these methods of derivation are rather cumbersome and, therefore, in our problem we wish to apply the reciprocity relation and the formulae obtained for second derivatives of τ in a more particular case than that considered here. Let us note, by the way, that the reciprocity principle is often applied in the theory of diffraction when the known formulae for the field of a wave moving in one direction are used to obtain or to generalize the expressions for a wave moving in the opposite direction.

Later on the formulae for the second derivatives of τ derived in the paper by Gelchinsky (1982a) are used. These formulae are valid when a wave with a front of arbitrary shape is scattered by a curved body and the receiver at point M and the specular point C_0 on the scattering surface are located in a homogeneous medium (Fig. 2). The formulae are also applicable to the case of converted waves (the velocities of the incident and reflected waves are not equal), as well as to the cases of reflection or refraction.

The following relations:

$$\begin{aligned} \alpha &= g_0^{\frac{1}{2}} \left\{ \frac{\cos^2 \theta_0^+}{\lambda^+ r_{\parallel}^+} + \frac{\cos^2 \theta_0^-}{\lambda^- l} + \frac{1}{R_{\parallel}} \left(\frac{\cos \theta_0^+}{\lambda^+} \pm \frac{\cos \theta_0^-}{\lambda^-} \right) \right\}, \\ \beta &= g_0^{\frac{1}{2}} \left\{ \frac{1}{\lambda^+ r_{\perp}^+} + \frac{1}{\lambda^- l} + \frac{1}{R_{\perp}} \left(\frac{\cos \theta_0^+}{\lambda^+} \pm \frac{\cos \theta_0^-}{\lambda^-} \right) \right\}, \\ \gamma &= g_0^{\frac{1}{2}} \left\{ \left(\frac{\cos \theta_0^+ \sin 2\phi^+}{\lambda^+} \right) \left(\frac{1}{r_1^+} - \frac{1}{r_2^+} \right) \right. \\ &\quad \left. + \sin 2\Phi \left(\frac{1}{R_1} - \frac{1}{R_2} \right) \left(\frac{\cos \theta_0^+}{\lambda^+} - \frac{\cos \theta_0^-}{\lambda^-} \right) \right\} \end{aligned} \quad (17)$$

were derived in the above-mentioned paper (see Eq. (28) in Gelchinsky, 1982a) for the second derivatives of the eiconal τ in Eq. (13).

Besides the notation introduced earlier, the following notation is used: $\lambda^{(v)}$ ($v = +$ or $-$) is the wavelength of the wave incident in the v -direction; $r_1^{(v)}$ and $r_2^{(v)}$ (R_1 and R_2) are the curvature radii of the principal normal sections of the wavefront $\Sigma^{(v)}$ (of the surface S); $r_{\parallel}^{(v)}$ and $r_{\perp}^{(v)}$ (R_{\parallel} and R_{\perp}) are the curvature radii of the normal sections of the wavefront $\Sigma^{(v)}$ (of the surface S) corresponding to the planes E_{\parallel} and E_{\perp} ($E_{\perp} \perp E_{\parallel}$); $\phi^{(v)}$ (Φ) is the angle between the plane of incidence E_{\parallel} and the first principal normal section of the front $\Sigma^{(v)}$ (of the surface S).

The curvature radius $R_j(r_j^{(v)})$ ($j = 1, 2$ or \parallel or \perp) is considered to be positive if the normal section of the surface S (of the front $\Sigma^{(v)}$) is a convex curve from the side of the incident wave. The quantity l is the distance between the point C_0 and point M :

$$l = CM = \tau^-(C_0) v^-. \quad (18)$$

The quantity g_0 is the determinant value for the metric tensor of the surface S in the special orthogonal curvilinear coordinate system p, q , determined by the following local condition at the point C_0 :

$$g_0^{\frac{1}{2}} = \left(\frac{\partial \mathbf{r}(p, q)}{\partial p} \right)^2 = \left(\frac{\partial \mathbf{r}(p, q)}{\partial q} \right)^2, \quad (19)$$

where $\mathbf{r}(p, q)$ is the radius vector to the specular point C_0 .

To generalize the obtained formulae to the case where there are intermediate surfaces between the reflection point C_0 and the point of observation C^- , we consider the formulae for the field, Eq. (8), from the reciprocity principle standpoint (or of the symmetry with respect to the direction of the wave propagation). It is easy to see that the formulae (8) and (9) and the position of the reflection point C_0 are symmetric in this sense. Only the formulae (17) for the second derivatives of the eiconal are not symmetric. Let us try to symmetrize them.

We begin by considering α . The formula for α contains the values characterizing waves incident in both the positive and negative directions. For example, θ_0^+ (θ_0^-) and λ^+ (λ^-) are the angle of incidence and the corresponding wavelength for propagation in the positive (negative) direction. At the same time, the quantities r_{\parallel}^+ and l are similar but not identical characteristics, as both are curvature radii. The difference between them is easily explained as follows: the front Σ^+ of the wave incident on S in the positive direction is not, generally speaking, spherical while the front of the wave incident on S from the point M is spherical because formulae (17) were derived for this case. To generalize the expression for α in the more general case where the front Σ^- is of arbitrary shape, we have to substitute the curvature radius r_{\parallel}^- of the normal section of Σ^- in the plane of incidence E_{\parallel} instead of the quantity l .

In addition, we change the rule for the sign of the curvature radii r_j^- and R_j^- ($j = 1, 2, +$ or $-$). The curvature radius \bar{R}_j^- or \bar{r}_j^- is considered to be positive

if the normal section of the surface S or of the front Σ^- is a convex curve from the side of the incident wave propagating in the negative direction. For example, if we consider the transmitted wave and $R_j^+ > 0$, then $R_j^- < 0$. Thus, according to the new rule for the sign of the curvature radii of the surface S and of the front Σ^- , there is only one sign in the corresponding parentheses in formulae (17).

Now the expression for α takes a symmetrized form. If we consider the formula for β in Eq. (17), it is easy to make an analogous generalization by substituting the curvature radius r_\perp^- of the normal section (in the plane E_\perp) of the front Σ^- instead of the quantity l .

Considering the expression of γ in Eq. (17), we observe that its nonsymmetry is determined by the fact that, from the negative side, the incident front Σ^- has a difference of the principal curvatures equal to zero. The generalization for the general case is easily carried out by addition to the formula for γ of the term analogous to the first item in the expression for γ . This additional term corresponds to the non-spherical wave incident on the negative side of the surface in the general case.

We can now write the symmetrized formulae for the second derivatives of τ :

$$\begin{aligned} \alpha &= g_0^{\frac{1}{2}} \left(\frac{\cos^2 \theta_0^+}{\lambda^+ r_\parallel^+} + \frac{\cos^2 \theta_0^-}{\lambda^- r_\parallel^-} + \frac{\cos \theta_0^+}{\lambda^+ R_\parallel^+} + \frac{\cos \theta_0^-}{\lambda^- R_\parallel^-} \right), \\ \beta &= g_0^{\frac{1}{2}} \left(\frac{1}{\lambda^+ r_\perp^+} + \frac{1}{\lambda^- r_\perp^-} + \frac{\cos \theta_0^+}{\lambda^+ R_\perp^+} + \frac{\cos \theta_0^-}{\lambda^- R_\perp^-} \right), \\ \gamma &= g_0^{\frac{1}{2}} \left\{ \frac{\cos \theta_0^+ \sin 2\phi^+}{\lambda^+} \left(\frac{1}{r_1^+} - \frac{1}{r_2^+} \right) \right. \\ &\quad + \frac{\cos \theta_0^- \sin 2\phi^-}{\lambda^-} \left(\frac{1}{r_1^-} - \frac{1}{r_2^-} \right) \\ &\quad \left. + \sin 2\Phi \left[\frac{\cos \theta_0^+}{\lambda^+} \left(\frac{1}{R_1^+} - \frac{1}{R_2^+} \right) + \frac{\cos \theta_0^-}{\lambda^-} \left(\frac{1}{R_1^-} - \frac{1}{R_2^-} \right) \right] \right\}. \end{aligned} \quad (20)$$

Thus we obtain formulae (12) and (20) for the radii of the Fresnel zone in the general case when the incident fronts Σ^+ and Σ^- are of arbitrary shape.

The formulae for the Fresnel volume

Let the position of the source and of the receiver at points M_+ and M_- be given and the ray path M_+M_- calculated (Fig. 4). The following procedure is then used to find the Fresnel volume surrounding the centre ray M_+M_- .

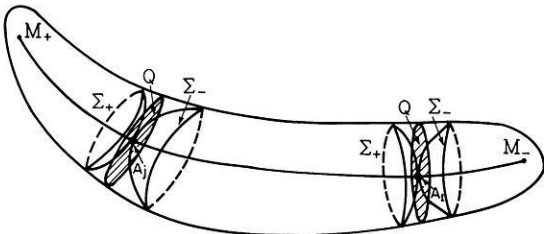

Fig. 4. Plot showing the Fresnel zone construction: Σ^+ (Σ^-) is the front arriving at the point A_j ($j=1, 2, \dots$) from source M_+ (receiver M_-); Q is the cross-section of the Fresnel volume

The fronts $\Sigma^+(A_j)$ and $\Sigma^-(A_j)$ arriving from the points M_+ and M_- to the point A_j are computed for the series of successive points $A_1, A_2, \dots, A_j, \dots$ on the ray. We then assume that the front $\Sigma^+(A_j)$ [and $\Sigma^-(A_j)$] coincides with the surface S . In this case the sizes of the curved Fresnel zones on the wavefronts $\Sigma^+(A_j)$ and $\Sigma^-(A_j)$ and of the Fresnel ellipse on the image planes $Q(A_j)$ can be determined with the help of the formulae derived above. The surface of the Fresnel volume is obtained as an envelope of the Fresnel zones (or of the ellipses) calculated on the series of points A_j ($j=1, 2, \dots$) along the central ray M_+M_- . In the case where the surface S coincides with the incident front [for example $\Sigma^+(A_j)$], the following relations hold at the point A_j :

$$\begin{aligned} \theta_0^+ &= \theta_0^- = \phi^+ = \Phi = 0, & \lambda^+ &= \lambda^- = \lambda, \\ r_1^+ &= r_\parallel^+ = R_1^+ = R_\parallel^+, & r_2^+ &= r_\perp^+ = R_2^+ = R_\perp^+. \end{aligned} \quad (21)$$

Taking into account the relation (21), we can rewrite the expression (20) in the form

$$\begin{aligned} \alpha &= \frac{g_0^{\frac{1}{2}}}{\lambda} \left(\frac{1}{r_1^+} + \frac{1}{r_\parallel^-} \right), & \beta &= \frac{g_0^{\frac{1}{2}}}{\lambda} \left(\frac{1}{r_2^+} + \frac{1}{r_\perp^-} \right), \\ \gamma &= \frac{g_0^{\frac{1}{2}}}{\lambda} \sin 2\Delta\phi \left(\frac{1}{r_1^-} - \frac{1}{r_2^-} \right), \end{aligned} \quad (22)$$

where $\Delta\phi$ is the angle between the two first principal normal planes of the fronts $\Sigma^+(A_j)$ and $\Sigma^-(A_j)$.

If we now substitute the values of α , β and γ from the relations (22) in the expression (12) for the Fresnel radii and use Euler's formula

$$\frac{1}{r_\parallel} = \frac{\cos^2 \phi}{r_1} + \frac{\sin^2 \phi}{r_2}, \quad (23)$$

we obtain the following equations:

$$1/r_f^{(j)} = |[c - (-1)^j d]|^{\frac{1}{2}}, \quad (24)$$

where

$$\begin{aligned} c &= 2g_0^{\frac{1}{2}}(h_+ + h_-)/\lambda, \\ d &= \{g_0(\Delta K_+^2 + \Delta K_-^2 + 2\Delta K_- \Delta K_+ \cos^2 2\Delta\phi)/\lambda^2\}^{\frac{1}{2}}, \end{aligned} \quad (25)$$

$$h_v = \frac{1}{2} \left(\frac{1}{r_1^{(v)}} + \frac{1}{r_2^{(v)}} \right),$$

$$\Delta K_v = \frac{1}{r_1^{(v)}} - \frac{1}{r_2^{(v)}}, \quad (v = + \text{ or } -).$$

The symmetrized invariant expressions (24) and (25) determine the radii of the curved Fresnel zones on the fronts Σ^+ and Σ^- or of the Fresnel ellipse in the normal cross-section of the Fresnel volume (in this case $g_0=1$) at the point A_j (Fig. 4).

Some physical consequences

Now we shall consider some implications connected with the formulae obtained. If the following inequalities hold:

$$\Delta p/r_f^{(1)} \gg 1, \quad \Delta q/r_f^{(2)} \gg 1, \quad (26)$$

$$p/r_f^{(1)} \gg 1, \quad q/r_f^{(2)} \gg 1, \quad (27)$$

where, as previously, Δp and Δq are the body sizes, p and q are the distances of the specular point C_0 from the corresponding body edges, $r_f^{(1)}$ and $r_f^{(2)}$ are the radii (semi-axes) of the Fresnel zone (Figs. 2 and 3), then the weakening function, Eq. (9), in Eq. (8) is:

$$W \simeq 1. \quad (28)$$

The relation (28) follows from the asymptotic formula for the Fresnel integrals in Eq. (9) (Abramovitz and Stegun, 1970). The equality of the weakening function W to unity means that the scattering by the body surface S is the "pure" reflection (refraction) occurring according to the laws of the ray method. The impact of the body edges (or of the diffraction effect) is then negligible, so that the reflection (refraction) takes place in accordance with the ray method if:

a) the scattering body is large-scaled, i.e. its sizes are large as compared to the Fresnel zone [conditions (26)];

b) the source and receiver (points C^+ and C^- in Fig. 1) are located in the lit area, i.e. the corresponding specular point (point C_0 in Fig. 2) is far from the body edges or from the boundary of the geometrical shadow [condition (27)].

From both physical and practical points of view, the inequalities (26) and (27), which follow from the conditions of validity of the asymptotic formulae for the Fresnel integrals, are, however, too strict. According to the well-known Fresnel explanation, the leading part of the wavefield at some point is determined by the first Fresnel zone as the contributions of the following even and odd zones extinguish each other. This physical interpretation of weak impact of the following Fresnel zones on the wavefield could easily be explained by the properties of an integral with a rapidly varying integrand, such as type (5). Therefore, the practical conditions for the pure reflection (refraction) can be written in the form:

$$\Delta p \gtrsim r_f^{(1)}, \quad \Delta q \gtrsim r_f^{(2)}, \quad (29)$$

$$p \gtrsim r_f^{(1)}, \quad q \gtrsim r_f^{(2)}. \quad (30)$$

Conditions (29) and (30) are necessary, but they are not sufficient to provide the pure reflection. In addition, it is necessary that the factor F in the integrand of integral (5) be a slowly varying function. The conditions which provide this property of factor F can be written in different forms (Felsen and Marcuvitz, 1973; Bleistein and Handlesman, 1975). We will use the following approximate condition of validity of the method of stationary phase:

$$r_f^{(\gamma)} \frac{\partial \ln F(\xi_1, \xi_2)}{\partial \xi_\gamma} \ll 1, \quad (\gamma = 1, 2), \quad (31)$$

where F is the integrand of integral (5) without an exponential factor, $\xi_1 = p$ and $\xi_2 = q$ are the curvilinear coordinates on the body surface S or on the fronts $\Sigma^+(A_j)$ and $\Sigma^-(A_j)$ (Figs. 2–4).

In the case of the plane Q tangent to S (Figs. 2 and

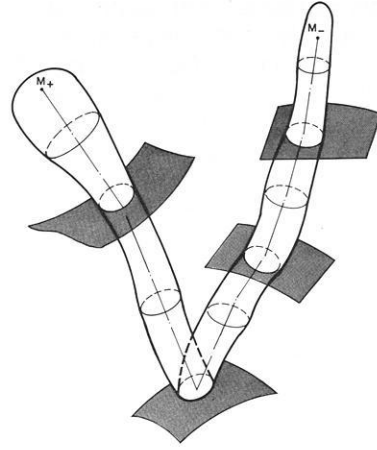

Fig. 5. The Fresnel volume for the reflected wave transmitted through three intermediate interfaces

3) or to Σ^+ and Σ^- (Fig. 4), the coordinate system ξ_1, ξ_2 could be replaced by the Cartesian:

$$\xi_1 = x, \quad \xi_2 = y. \quad (32)$$

The conditions of Eq. (31) impose some restrictions on the speed of variation of the wavefield and of the medium parameters. We can rewrite them in the form:

$$r_f^{(j)} \frac{\partial \ln I}{\partial \xi_j} \ll 1, \quad r_f^{(j)} \frac{\partial \ln K}{\partial \xi_j} \ll 1, \quad (33)$$

$$r_f^{(j)} \frac{\partial \ln v}{\partial \xi_j} \ll 1 \quad (j = 1, 2),$$

where I is the wave amplitude, K is the coefficient of reflection, v is the velocity of wave propagation.

These conditions, Eq. (33), of validity of the method of stationary phase also prove to be too strict from the practical (physical) point of view. The comparison of data obtained by calculation according to asymptotic formulae (in particular in the Kirchhoff approximation) and according to the exact numerical or analytical formulae, or by physical modelling, shows that the asymptotic formulae give a fairly good approximation when the conditions

$$r_f^{(j)} \frac{\partial \ln I}{\partial \xi_j} \gtrsim 1, \quad r_f^{(j)} \frac{\partial \ln K}{\partial \xi_j} \gtrsim 1, \quad (34)$$

$$r_f^{(j)} \frac{\partial \ln v}{\partial \xi_j} \gtrsim 1 \quad (j = 1, 2)$$

are met (Vainstein, 1957; Felsen and Marcuvitz, 1973; James, 1974; Zahradnik, 1977; Borovikov and Kinber, 1978; Gelchinsky and Karaev, 1980).

This consideration together with conditions (29) and (30) form the basis of the assertion that the Fresnel volume (zone) is the area essential for propagation (reflection). In other words, the Fresnel volume (zone) is the domain in which the wavefield coming from the source M_+ to the receiver M_- is formed (Figs. 2 and 4). From this fact in particular, it follows that the resolution of the seismic method is determined by the sizes of the Fresnel volume and the Fresnel zones surrounding the ray $M_+ M_-$ (Fig. 5).

Let us now consider the structure of the formulae (12), (22), (24) and (25) for the radii of the Fresnel zone and volume. The important peculiarity of the formulae obtained is their locally invariant form, i.e. that all the quantities included in them are characteristics of the medium and fronts at the centre of the zone (point C_0 or A_j on Figs. 2–4) and are independent of the choice of coordinate system.

The formulae (20) and (25) include the value g_0 . This quantity is the determinant value for the metric tensor of the scattering surface S [or the fronts $\Sigma^+(A_j)$ or $\Sigma^-(A_j)$] in the special coordinate system (p, q) at the specular point C_0 (Fig. 2) [or at the considered point A_j on the centre ray M_+M_- – Fig. 4]. The directions of the coordinate lines at the origin C_0 (or A_j) are tangent to the corresponding Fresnel areas (Fig. 2); owing to the local conditions, Eq. (18), this coordinate system can be called the quasi-Cartesian. Thus, the orthogonal curvilinear coordinate system (p, q) is determined by the orientation of the Fresnel zone on the surface S (or Σ^+ or Σ^-) and by the geometry of S (or Σ^+ or Σ^-).

The formulae (20) and (25) for the Fresnel radii have a symmetrized form, i.e. they do not change if the source and the receiver exchange places at the fixed points A^+ and A^- . These formulae include three types of terms: the first depends on the geometrical characteristic of the front Σ^+ , on its velocity and on the orientation of the plane of incidence E_{\parallel} ; the second depends on the characteristics of the Σ^- , v and E_{\parallel} ; and the third on the geometrical characteristics of the scattering (reflecting) surface and on E_{\parallel} .

The formulae obtained are essentially simplified in particular cases. For example, if the plane of incidence, E_{\parallel} , coincides with the principal normal sections of the fronts Σ^+ , Σ^- and the scattering surface S at the specular point C_0 , then the radii of the Fresnel zone are determined by the expressions:

$$\frac{1}{r_f^{(1)}} = g_0^{\frac{1}{2}} \left| \left(\frac{\cos^2 \theta^+}{\lambda^+ r_1^+} + \frac{\cos^2 \theta^-}{\lambda^- r_1^-} + \frac{\cos \theta^+}{\lambda^+ R_1^+} + \frac{\cos \theta^-}{\lambda^- R_1^-} \right) \right|^{\frac{1}{2}} \quad (35)$$

$$\frac{1}{r_f^{(2)}} = g_0^{\frac{1}{2}} \left| \left(\frac{1}{\lambda^+ r_2^+} + \frac{1}{\lambda^- r_2^-} + \frac{1}{\lambda^+ R_2^+} + \frac{1}{\lambda^- R_2^-} \right) \right|^{\frac{1}{2}},$$

where

$$r_1^{(v)} = r_{\parallel}^{(v)}, \quad r_2^{(v)} = r_{\perp}^{(v)},$$

$$R_1^{(v)} = R_{\parallel}^{(v)}, \quad R_2^{(v)} = R_{\perp}^{(v)}, \quad (v = + \text{ or } -). \quad (36)$$

The analogous formulae for the Fresnel volume (Fig. 4), in the case where the angle $\Delta\phi$ between the first principal normal section of the fronts $\Sigma^+(A_j)$ and $\Sigma^-(A_j)$ is equal to zero, take the form:

$$\frac{1}{r_f^{(1)}} = \left| \frac{1}{r_1^+} + \frac{1}{r_2^+} \right|, \quad \frac{1}{r_f^{(2)}} = \left| \frac{1}{r_1^-} + \frac{1}{r_2^-} \right|. \quad (37)$$

It should be noted that the level of difficulty in the calculation of the Fresnel radii $r_f^{(i)}$ ($i=1, 2$) according to formulae (12), (20), (24) and (25), is of the same order as that for the computations of the radii of curvature of the fronts Σ^+ and Σ^- . The procedure for the calculation of the curvature of wavefronts is described in various

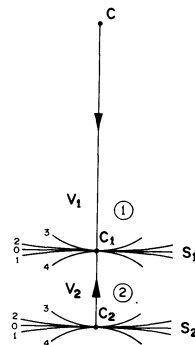

Fig. 6. Sketches of the cross-sections of the considered models in the plane of incidence E_{\parallel} : $v_1 = 2,500$ m/s; $v_2 = 4,000$ m/s; $CC_1 = 1,500$ m; $C_1C_2 = 500$ m; $R_1^{(i)}(N)$ is the N -th version ($N = 0, 1, 2, 3, 4$) of the principal radius of curvature of the interface S_i ($i=1, 2$) in the plane $E_1 = E_{\parallel}$; $R_1^{(i)}(0) = \infty$; $R_1^{(i)}(1) = 4,000$ m; $R_1^{(i)}(2) = -4,000$ m; $R_1^{(i)}(3) = 500$ m; $R_1^{(i)}(4) = -500$ m

works (see, for example, Gelchinsky, 1958, 1961; Červený and Ravindra, 1971; Deschamps, 1972; Shah, 1973; Hubral, 1980). Particularly useful in this sense is the work by Hubral and Krey (1980) in which these procedures are treated systematically in the context of solving the general problem of seismic prospecting.

We now present the numerical illustration of the results obtained. The model under consideration is the two layers on the half-space (Fig. 6). The principal normal planes E_1 to both interfaces S_1 and S_2 coincide. The 25 versions of the model corresponding to the five values of the radius of curvature, $R_1^{(i)}$, of the principal normal section to each interface S_i ($i=1, 2$) in the plane E_1 were considered (Fig. 6). It was also assumed that the radius of curvature, $R_2^{(i)}$ of each interface in the plane E_2 ($E_2 \perp E_1$) was the same for all versions of the model and was equal to infinity.

The Fresnel zones and volumes for the frequency $\nu = 40$ Hz and for the central normal ray of waves reflected from S_2 were calculated. The thickness CC_1 or C_1C_2 of each layer in the normal direction does not change, therefore the zero time and the average velocity for the wave reflected from S_2 remain the same in each version considered. In the situation under consideration, the plane of incidence E_{\parallel} coincides with the principal normal plane E_1 for S_1 and S_2 , so that formulae (35) and (37) for the Fresnel zone and volume are valid.

Sizes computed for the half-axes, $r_f^{(i)}$, of the Fresnel ellipses in E_{\parallel} for the interfaces S_1 and S_2 are presented in Tables 1 and 2.

Table 1. The radii of the Fresnel ellipses on plane Q tangent to the interface S_1 in the plane E_{\parallel}

$R_2^{(2)}$ (m)	$R_1^{(1)}$ (m)				
	∞	4,000	-4,000	500	-500
∞	250	242	269	183	580
4,000	210	204	248	174	769
-4,000	298	263	312	206	306
500	201	193	208	165	291
-500	128	126	131	102	170

Table 2. The radii of the Fresnel ellipses on plane Q tangent to the interface S_2 in the plane E_{\parallel}

$R_1^{(2)}$ (m)	$R_1^{(1)}$ (m)				
	∞	4,000	-4,000	500	-500
∞	268	258	285	216	587
4,000	231	224	240	194	690
-4,000	335	312	368	246	357
500	136	134	138	116	164
-500	208	201	190	236	159

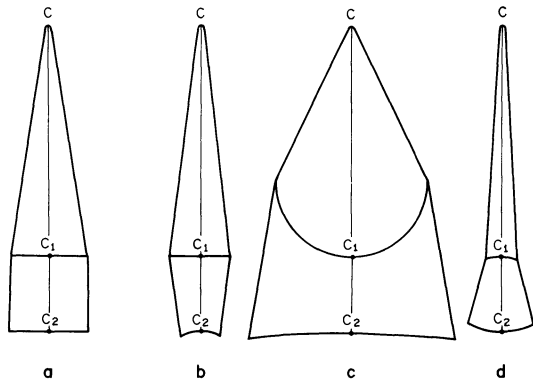

Fig. 7a-d. Examples of the cross-sections of the Fresnel volumes in E_{\parallel} for some of the models shown in Fig. 6: **a** Cross-section for model with $R_1^{(1)}(0)=R_1^{(2)}(0)=\infty$; **b** Cross-section for model with $R_1^{(1)}(0)=\infty$; $R_1^{(2)}(3)=500$ m; **c** Cross-section for model with $R_1^{(1)}(4)=-500$ m; $R_1^{(2)}(2)=4,000$ m; **d** Cross-section for model with $R_1^{(1)}(3)=500$ m; $R_1^{(2)}(4)=-500$ m

In all versions the Fresnel radii $r_f^{(2)}$ in the plane $E_2=E_1$ are equal to 250 m for S_1 and 268 m for S_2 .

The four examples of the calculated cross-section of Fresnel volumes in the plane E_{\parallel} are shown in Fig. 7. The calculated data show that the Fresnel zones and volumes can be essentially different for waves with a fixed central ray in the models with fixed values of interval velocities and time of wave propagation along the ray. The essential changes in the Fresnel zones and volumes can take place when the ray path crosses the interface with a large curvature. In the theory of wave propagation, it is accepted that the presence of inhomogeneities with large curvature (or with large gradients) along the ray results in essential decreases in the Fresnel zone (Tatarsky, 1967; Flatte, 1979). The data presented show that the intersection of the central ray with the surface of large curvature could lead to an increase or decrease in the Fresnel zones and volumes as compared to the case of smooth interfaces. The results obtained can be explained as the effects of strong focusing or defocusing of rays intersecting the interfaces with large curvature – for example, the Fresnel volume in Fig. 7c is essentially larger than that in Fig. 7a.

Such a decrease in the Fresnel zone is caused by strong defocusing of rays transmitted through the first surface S_1 with large curvature ($R_1^{(1)}=-500$). It is useful to note that the essential changes considered in the Fresnel zones and volumes are not isolated effects, but are also accompanied by strong variations in the kinematic and dynamic properties of the wavefield. In particular, the RMS velocities are also altered in these cases, although the zero time and average velocity remain constant.

In conclusion, it should be noted that the Fresnel radii are also important characteristics in cases where scattering by a body differs essentially from reflection (refraction). Generally speaking, this problem is the subject of special consideration and we wish only to point out here that in some of these cases [e.g. when the reflection (refraction) properties change rapidly over the length of the Fresnel radii, $r_f^{(i)}$], the complex parameter, $\rho_f^{(i)}$, characterizing the variation of a wavefield could be introduced (Gelchinsky, 1982b). This parameter is called the Fresnel parameter: its imaginary part is equal to the corresponding Fresnel radii, $r_f^{(i)}$, and its real part characterizes the speed of variation of the reflection properties. The behaviour and resolution of the wavefield depends on the relation between the imaginary part and the real part of the Fresnel parameter.

Acknowledgements. The author wishes to express his gratitude to Dr. Peter Hubral and Dr. Morris Podolak who read the manuscript and made valuable comments.

References

- Abramovitz, M., Stegun, I.: Handbook of mathematical functions with formulae, graphs and mathematical tables. Washington D.C., National Bureau of Standards, Applied Mathematics Series 55, 1970
- Alekseev, A.S., Gelchinsky, B.: On the ray method of computation of a wave field for inhomogeneous media with curved interfaces. In: Problems in the dynamic theory of seismic wave propagation (in Russian) **3**, 102–160, Leningrad University Press 1959
- Al'pert, Yal, Ginzburg, V.L., Fainberg, E.H.: Radio wave propagation (in Russian). Moscow Fizmatgiz, 1953
- Bertonei, H.L., Felsen, L.B., Hessel, A.: Local properties of radiation in lossy media. IEEE Trans. AP-19, N-3, 226–238, 1971
- Bleistein, N., Handelsman, R.: Asymptotic expansions of integrals. New York: Holt, Rinehard and Wiston 1975
- Born, M., Wolf, E.: Principles of optics. Oxford: Pergamon Press 1980
- Borovikov, V.A., Kinber, E.E.: Geometrical theory of diffraction (in Russian). Moscow Svjaz, 1978
- Červený, V., Ravindra, R.: Theory of seismic head waves. University of Toronto Press, 1971
- Deschamps, G.H.: Ray techniques in electromagnetics. Proceedings of the IEEE, **60**, 1022–1035, 1972
- Felsen, L.B., Marcuvitz, N.: Radiation and scattering of waves. New Jersey: Prentice-Hall 1973
- Flatte, S.M. (Ed.): Sound transmission through a fluctuating ocean. Cambridge University Press, 1979
- Gelchinsky, B.: Calculation of the spreading function of rays in layered homogeneous isotropic media. In: Materials of quantitative investigations of dynamics of seismic waves (in Russian), Vol. 3, Petrashen, G.I., ed.: pp. 295–305. Leningrad University Press, 1958
- Gelchinsky, B.: An expression for the spreading function. In: Problems in dynamic theory of seismic wave propagation (in Russian), Vol. 5, Petrashen, G.I., ed.: pp. 47–53. Leningrad University Press, 1961
- Gelchinsky, B.: Scattering of waves by a quasi-thin body of arbitrary shape. Geophys. J.R. Astron. Soc. **71**, 425–453, 1982a

- Gelchinsky, B.: Formulae for field of wave scattered by an inhomogeneous body and regions essential for reflection and propagation. Technical Program of 52nd Annual Meeting of SEG, 173-174, Dallas, 1982b
- Gelchinsky, B., Karaev, N.: Theoretical and model investigation waves scattered by quasithin bodies of arbitrary shape. *Ann. Geophys.* **36**, 509-518, 1980
- Hagedoorn, T.G.: The process of seismic reflection interpretation. *Geophys. Prospecting* **2**, 85-127, 1959
- Hilterman, F.T.: Three-dimensional seismic modeling. *Geophysics* **35**, 1020-1037, 1970
- Hubral, P.: Wavefront curvatures in three-dimensional laterally inhomogeneous media with curved interfaces. *Geophysics* **45**, 905-913, 1980
- Hubral, P., Krey, T.H.: Interval velocities from seismic reflection time measurements. Society of Exploration Geophysicists, Tulsa, 1980
- James, G.L.: Geometrical theory of diffraction. Peter Peregrinus, Stevenage, England, 1974
- Keller, J.B.: Diffraction by an aperture. *Appl. Phys.* **28**, 426-445, 1957
- Kleyn, A.H.: Seismic reflection interpretation. Applied Science, New York, 1983
- Kravtsov, Y.A., Orlov, Y.A.: The geometrical optics of inhomogeneous media (in Russian). Moscow: Nauka Press 1980
- Shah, P.M.: Use of wavefront curvature to relate seismic data with subsurface parameters. *Geophysics* **38**, 812-825, 1973
- Sheriff, R.E.: Nomogram for Fresnel-zone calculation. *Geophysics* **45**, 968-972, 1980
- Sheriff, R.E., Geldart, L.P.: Exploration seismology, Vol. 1. Cambridge University Press, 1982
- Tatarsky, V.I.: Wave propagation in a turbulent atmosphere (in Russian). Moscow: Nauka Press 1967. [Translated into English: The effects of the turbulent atmosphere on wave propagation. Israel Program for Scientific Translation, Jerusalem, 1971]
- Vainstein, L.A.: Electromagnetic waves (in Russian). Moscow Sovetskoe Radio, 1957
- Zahradnik, T.U.: SH-waves in the vicinity of rectangular impenetrable wedge. *Ann. Geophys.* **33**, 201-207, 1977

Received July 18, 1984; Revised version February 18, 1985

Accepted March 25, 1985